



## Socket + Glass

3, 5, or 7 Swag Chandelier

Assembly Instructions



Your glass may look different.

### Questions?

**Email:** [support@virolighting.com](mailto:support@virolighting.com)

**Phone:** 385-799-6966



THIS PRODUCT MUST BE INSTALLED IN ACCORDANCE WITH THE APPLICABLE INSTALLATION CODE BY A PERSON FAMILIAR WITH THE CONSTRUCTION AND OPERATION OF THE PRODUCT AND THE HAZARDS INVOLVED

## Included Tools

Mini flathead screwdriver  
Allen wrench

## Tools Needed

Phillips head screwdriver  
Wire stripper  
Electrical tape

1. **Do not** cut the cord until you complete the assembly of your fixture.



2. Before installing, turn off power at the circuit breaker or fuse box. Failure to do so may result in serious injury or electrical shock.

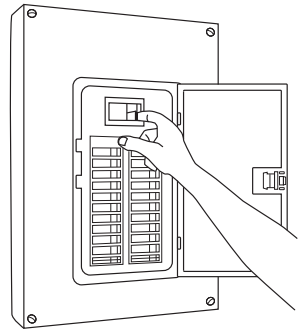



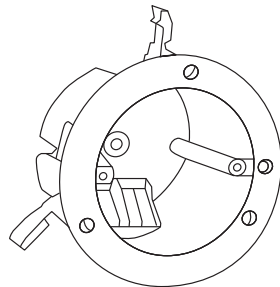



3. A 4" round junction box or smaller, rated for ceiling pendants is required for install (not included).

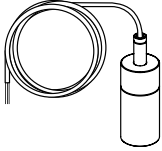

# Parts List - Names and Quantities

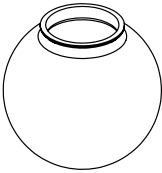
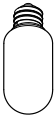
## 3, 5, or 7 Swag Chandelier

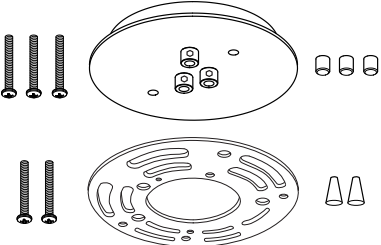
	<p><b>3, 5, or 7 Socket + Cord</b> VIRO-PEN-0001-XXX</p>
	<p><b>3, 5, or 7 Check Ring A</b> VIRO-COM-0007-XXX</p>
	<p><b>3, 5, or 7 Glass Adapter Cap</b> VIRO-COM-0010-XXX</p>
	<p><b>3, 5, or 7 Glass Adapter + 3 Set Screws</b> VIRO-COM-0009-BLK</p>
	<p><b>3, 5, or 7 Glass</b> <b>Your glass may look different.</b> VIRO-GLS-XXXX-XXX</p>
	<p><b>3, 5, or 7 Bulbs</b> <b>Your bulbs may look different.</b></p>
	<p><b>3, 5, or 7 Swag Hook Kits</b></p>
	<p><b>1 Canopy + 1 Universal Mount 2 8-32 Junction Box Screws 3 Canopy Mount Threaded Rods 2 Locking Nuts 3 Wire Nuts</b> VIRO-CAN-000X-XXX</p>

# Step 1: Disassemble the Socket

Hand unscrew each part in the order shown. Slide them off the cord **one at a time** and place them to the side for reassembly.

**ATTENTION:** **slowly** slide parts off and on the cord so you don't fray the cord. Any fraying that does occur can be removed by gently brushing the cord with a lighter.

**ATTENTION:** If untwisting the bottom portion of the socket, **avoid applying excessive force**, as it may damage the wires.

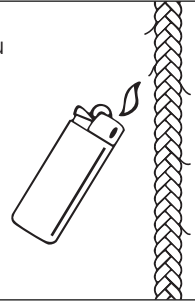

## Start here:

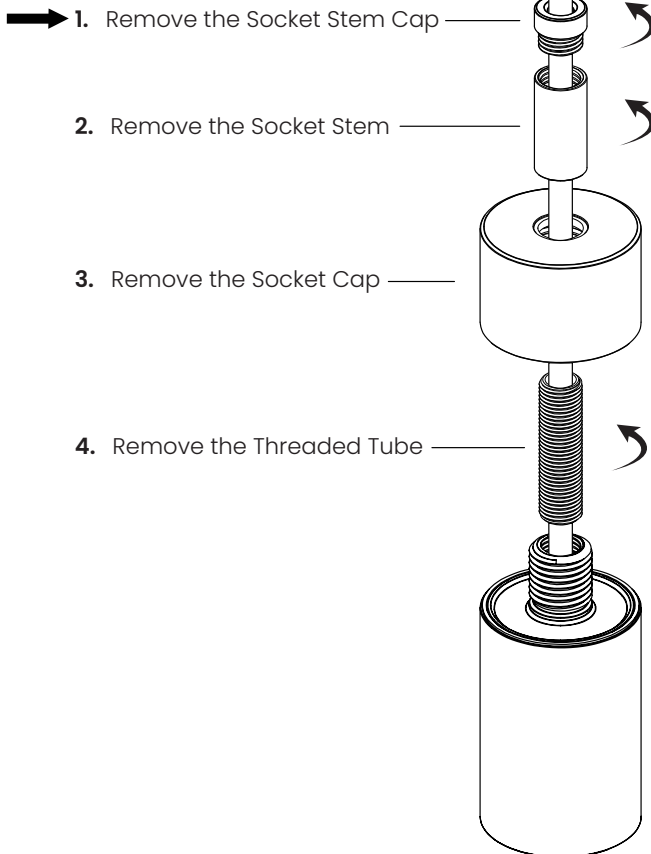

➔ 1. Remove the Socket Stem Cap

2. Remove the Socket Stem

3. Remove the Socket Cap

4. Remove the Threaded Tube

# Step 2: Assemble the Fixture

Assemble the following parts, one at a time:

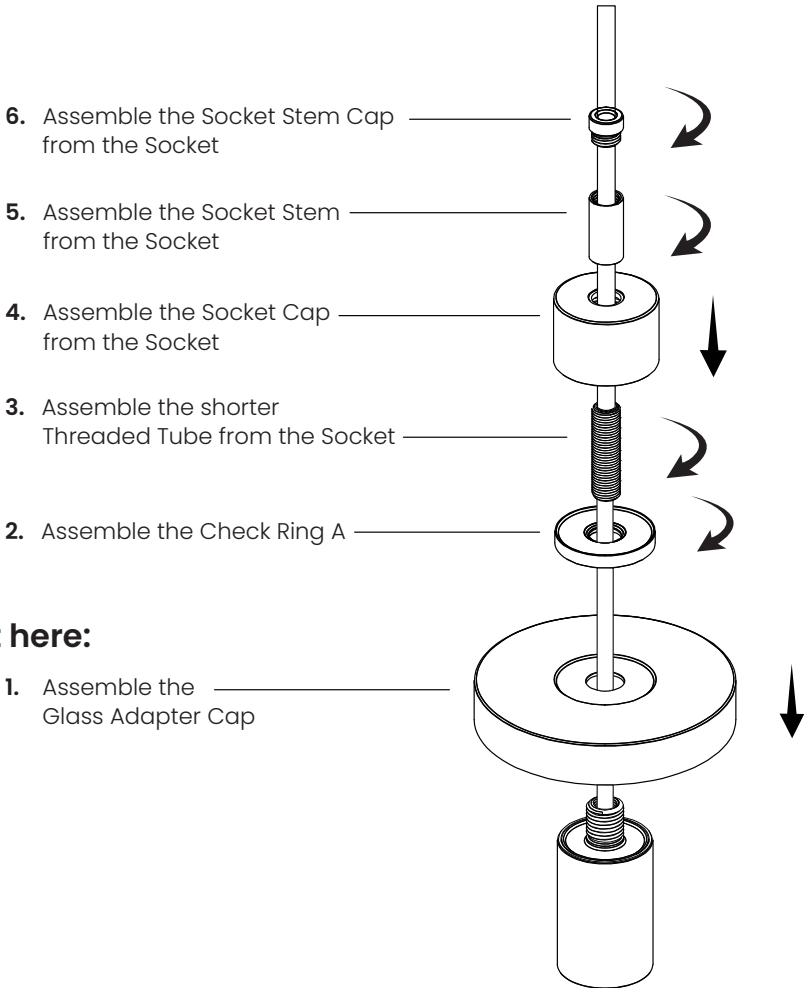

## Attach the Glass Adapter to the top of the Glass.

1. Before placing the Glass Adapter on the glass, **remove any obstructions or residue** surrounding the inside of the three drill holes. This will prevent you from stripping the set screws.

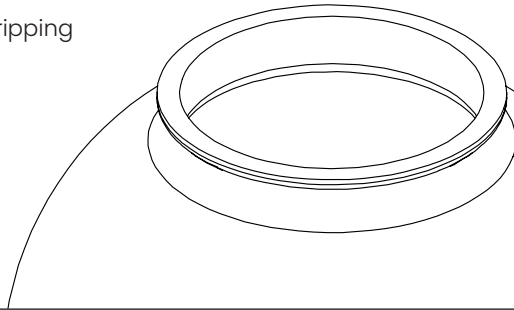
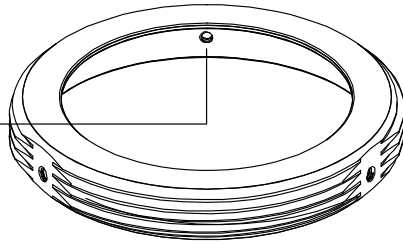

2. Using the included flat head screwdriver, carefully screw the included set screws into place until they are flush with the Glass Adapter. **Do not overtighten or strip** the screws.

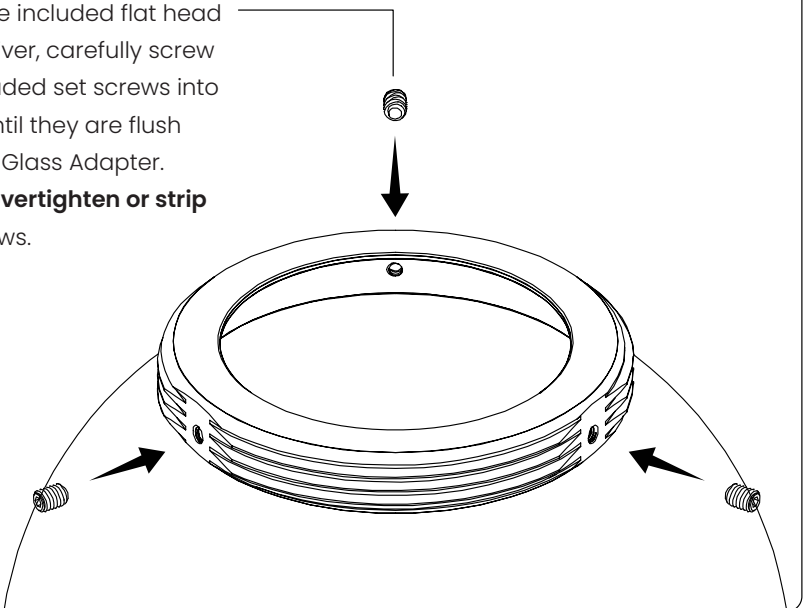

## Step 4: Assemble the Bulb and Glass

**Install the Bulb and securely attach the Glass to the Fixture.  
Be sure not to overtighten the Glass.**

1. Assemble the Bulb

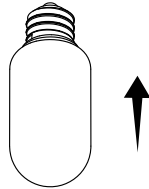

2. Assemble the Glass

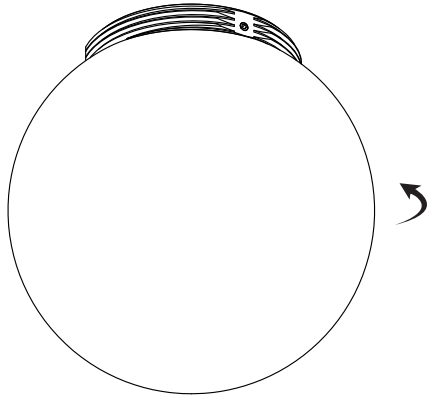

**Repeat steps 1-4 for all sockets and glass.**

## 1. Determine Desired Distance

Use a measuring tape to determine the desired position of the Swag Hooks radially around where the Canopy will be installed as well as the desired sag in each Cord.

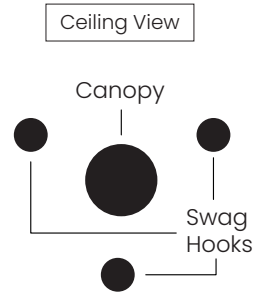

## 2. Install Swag Hooks

Using the included hardware, install the Swag Hooks and hang each Cord. Swag hooks can be installed to a joist or to drywall. If installing into drywall, use the provided anchors.

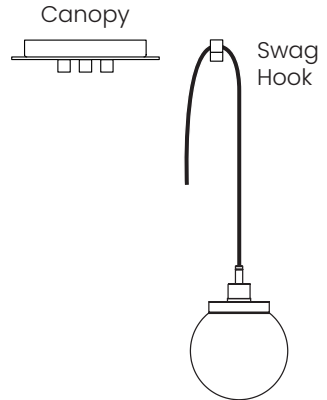

### **WARNING:**

The Canopy **CANNOT** support the weight of each glass. **DO NOT** connect lights to the Canopy until the weight of each glass is supported by the Swag Hooks.

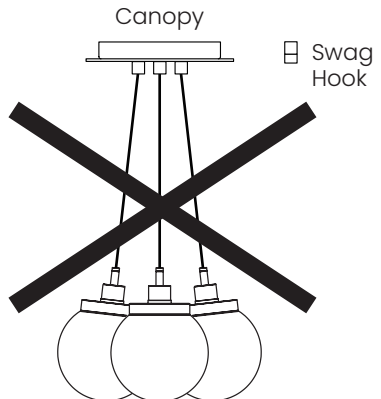

## 1. Cut the Cord

Use a razor or wire stripper to cut the Cord. Before cutting each Cord, keep in mind that about 6" of Cord is needed inside the Canopy to connect the wiring to the driver.

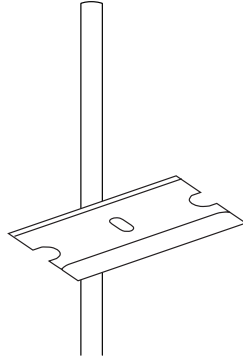

## 2. Remove Outer Housing

Moving about 2" down from the new end of the cord, use a wire stripper to gently score into and around the Fabric Cord. Do this a few times until you can twist and pull away the outer housing to expose the wires. Be careful not to cut into any of the wires.

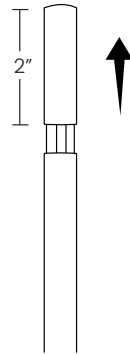

## 3. Tape the Cord

Use a thin strip of electrical tape to tape the fabric to the wires to prevent the fabric from sliding down. (If the tape is too thick you will not be able to slide the cord through the Canopy).

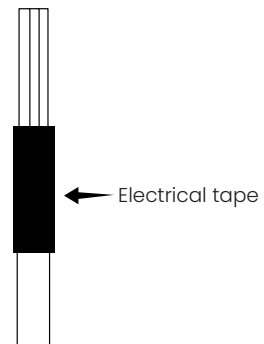

## 1. Strip the Wiring (if necessary)

If you cut the Cord on the previous page, expose the wiring by removing about 1/2" of insulation on all three wires. Using a wire stripper, clamp down on each wire and pull off the insulation.

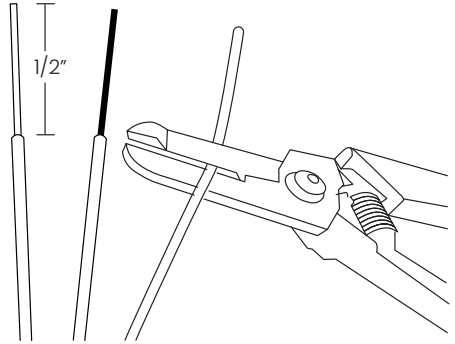

## 2. Slide the Cord into the Canopy

Before installing the Canopy, insert the Cord into the Canopy and lock it tightly into place by using the included set screw and allen wrench.

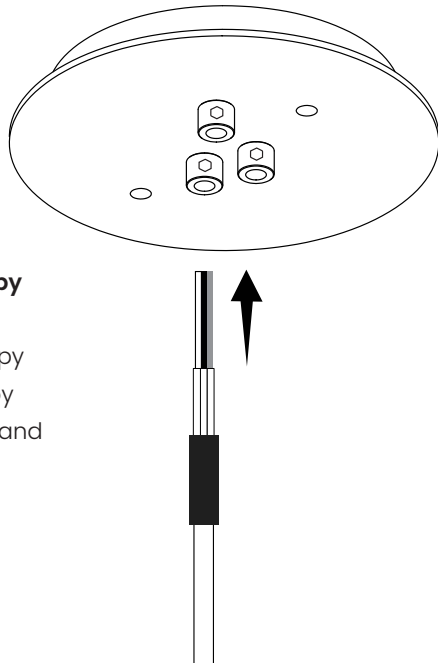

**Repeat steps 6-7 for each Cord.**

# Step 8: Prepare the Canopy

## 1. Install the Universal Mount (Included with the Canopy)

Using the included screws, attach the Universal Mount onto the ceiling junction box.

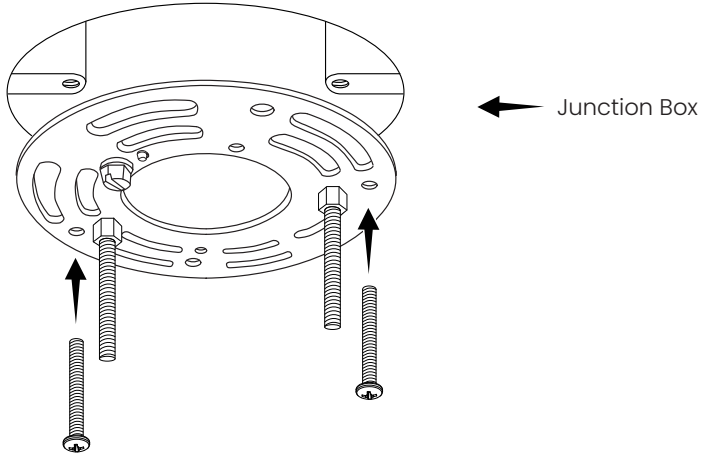

## 2. Connect and Cap the Wiring

Match and cap all ground wires (green) and connect to the ground screw.  
Match and cap all power wires (black). Match and cap all neutral wires (white).

## 3. Align the Canopy

Slide the Canopy into place by aligning the Canopy onto the Mounting Rods.

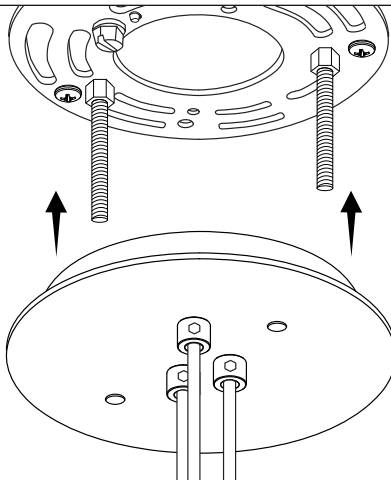

1. Screw the Locking Nuts onto the Canopy Mounting Rods to lock the Canopy into place.

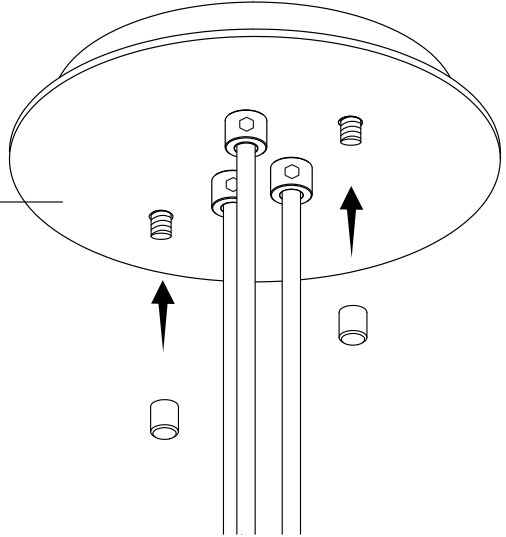

## 2. Download the Viro app

### If you purchased Smart Bulbs:

Utilize all the capabilities of your Smart Bulbs by connecting them to our Viro app. To do so, download the app and follow the prompts.



**When you first turn on your fixture,** your Smart Bulbs will begin to flash. The flashing indicates that the Bulbs are ready to pair with the app. Once you sync the Bulbs with the app, the flashing will stop.

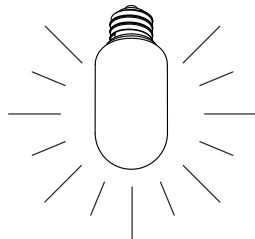

## Register your fixture

Get access to faster support and important updates. It only takes a minute.



## Leave a review

Help us improve the product and install experience.



## Share your finished installation

We'd love to see how it looks in your home! Use hashtag #virolighting and tag us.

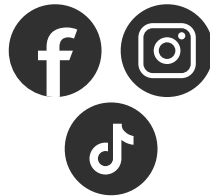

**Thank you for your purchase!**



[www.virolighting.com](http://www.virolighting.com)